

Procedure to file Request to the Eurasian Patent Office (EAPO) for accelerated patent prosecution of patent application in accordance with the Patent Prosecution Highway Programme between the Eurasian Patent Office and the European Patent Office (EPO)

1. Requirements

(a) The EAPO application (included the PCT application entered into regional phase at EAPO) for which participation in the Patent Prosecution Highway Programme between the EAPO and the EPO (PPH Programme) is requested and the corresponding application on the basis of which the request on participation in PPH is filed shall have the same date of priority or the same date of filing.

The corresponding application forming the basis for filing a PPH request (EPO application), may be:

(i) the application filed with EPO (examples brought in the attached Annex 1, pic. A-M) or;

(ii) the PCT application, in which the EPO acts as an International Searching Authority (ISA) and/or International Preliminary Examining Authority (IPEA) (examples brought in the attached Annex 2, pic. A-E).

(b) The corresponding application shall contain at least one claim determined as patentable by EPO acting as a regional patent office or as an ISA and/or an IPEA. The claim recognized as having novelty, inventive step and industrial applicability by EPO shall, for the purpose of this document, be deemed as patentable.

The EPO application claims shall be deemed as “determined as patentable” if an EPO examiner has explicitly identified the invention as patentable in the last office action OK, even if patent on this application is not yet granted.

(c) All claims of the EAPO application, as originally filed or as amended, for which a PPH request is filed must sufficiently correspond to one or more of those claims determined as patentable by EPO.

Claims are considered to “sufficiently correspond” where, accounting for differences due to translation into Russian and claim format, the claims in the Eurasian application are of the same or similar scope as the claims in the EPO application, or the claims in the Eurasian application are narrower in scope than the claims in the EPO application.

A claim shall be deemed narrower in scope if an EPO application claim is amended to be further limited by an additional feature that is supported in the specification (description and/or claims).

A claim in the EAPO application which introduces a new/different category of claims to those claims indicated as patentable in the EPO application shall not be deemed to sufficiently correspond if it represents a new or another category

of claims compared to those claims recognized as acceptable by EPO. For example, where the claims in the EPO application only contain claims to a process of manufacturing a product, then the claims in the EAPO application are not considered to sufficiently correspond if the claims in the EAPO application introduce product claims that are dependent on the corresponding process claims.

It is not necessary that all the EPO application claims recognized as patentable be fully reproduced in the EAPO application (the exclusion of the claims is permissible).

Any claims amended or added after the grant of the request for participation in the PPH Programme, but before the first EAPO office action, need to sufficiently correspond to the claims indicated as patentable in the EPO application. Any claims amended or added after the first EAPO office action, need not to sufficiently correspond to the claims indicated as patentable in EPO application, provided that the amendments are made by the applicant with the aim of elimination of the examination remarks objections regarding the invention/claim not to correspond the requirements of the Patent Regulations under EAPC.

(d) Substantive examination of the application has not begun at the moment of filing the request for the PPH with EAPO.

(e) For EAPO application, applicant must request for the substantive examination and pay the fees prescribed for substantive examination.

2. Documents to be submitted

To qualify for participation in the PPH Programme an applicant shall submit:

a) request to EAPO for participation in the PPH Programme (PPH request). The PPH Request Form is available at www.eapo.org in the section Documents/electronic forms;

b) copies of all office actions (which are relevant to substantial examination for patentability in EPO) which were issued for the corresponding application, and Russian or English translations thereof, or a copy of the last work product in the international PCT phase, i.e. ISA report, or IPEA report (in case the request was filed in compliance with PCT Chapter II) or the International Preliminary Examination Report (IPER) as well as the Russian or English translation thereof;

(c) copies of all claims indicated as patentable in EPO and Russian or English translation thereof;

(d) copies of documents cited by EPO examiner.

If the cited document is a patent document the applicant needs not present it as this kind of documents are usually accessible for EAPO. In case EAPO does not possess the required document the applicant must submit this patent

document at the request of the examiner. Non-patent literature shall always be submitted. Submission of translation of the cited documents is required if their translation into Russian or English is not available;

(e) a table of claims correspondence.

The applicant submitting PPH request must submit a table of the claims correspondence that explains the correspondence of the claims in the Eurasian application to the claims that are recognized as patentable in the EPO application.

If the claims are translated literally the applicant may write in the table "claims are identical". If the claims are not a literal translation, the table should explain the conformity of each claim.

If the applicant has already submitted to the EAPO the documents specified in subparagraphs (b) to (e) during simultaneous or previous procedures, he can include them by referring to them, without attaching the documents themselves. If the documents specified in subparagraphs (b) and (c) are available in DAS (Digital Access Service) or PATENTSCOPE systems, the applicant is not required to file copies of the documents, but must provide a list of documents to be retrieved. For the documents specified in subparagraphs (b) and (c), the use of machine translation is permissible. In case of poor quality of machine translation, EAPO may ask the applicant to provide an accurate translation. If EPO application is not published, then the applicant must submit the documents specified in subparagraphs (b) and (c) above when applying for the PPH application.

3. Procedure for considering the request for the PPH Programme

The decision to satisfy the PPH request is made subject to the fulfillment of all the requirements specified in paragraphs 1 and 2 of this Procedure, which the applicant is notified about.

If all the requirements necessary to satisfy the PPH request are not complied with by the applicant and which can be eliminated by the applicant, EAPO shall notify the applicant about the need to correct the identified deficiencies within the time specified in the notification.

If the applicant does not eliminate these shortcomings, EAPO will inform the applicant of the refusal to satisfy the request. In this case, the Eurasian application is subject to examination in the order of priority within the framework of the EAPO procedure.

A

Example 1 – Procedure in compliance with the Paris Convention

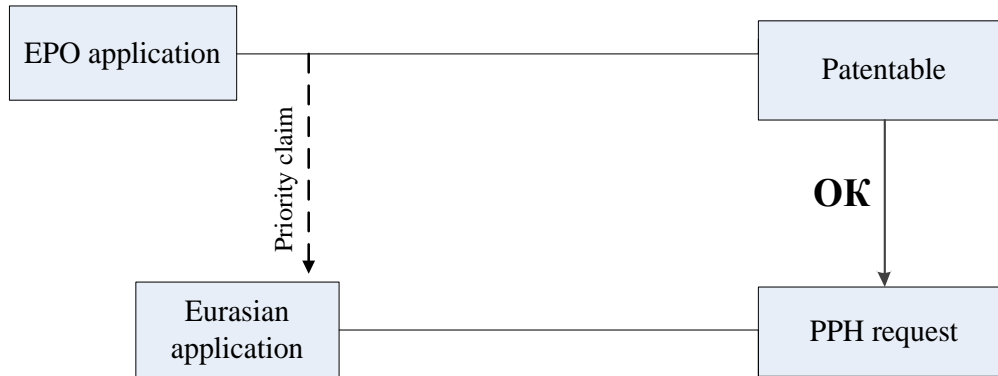

B

Example 1 – Procedure in compliance with the PCT

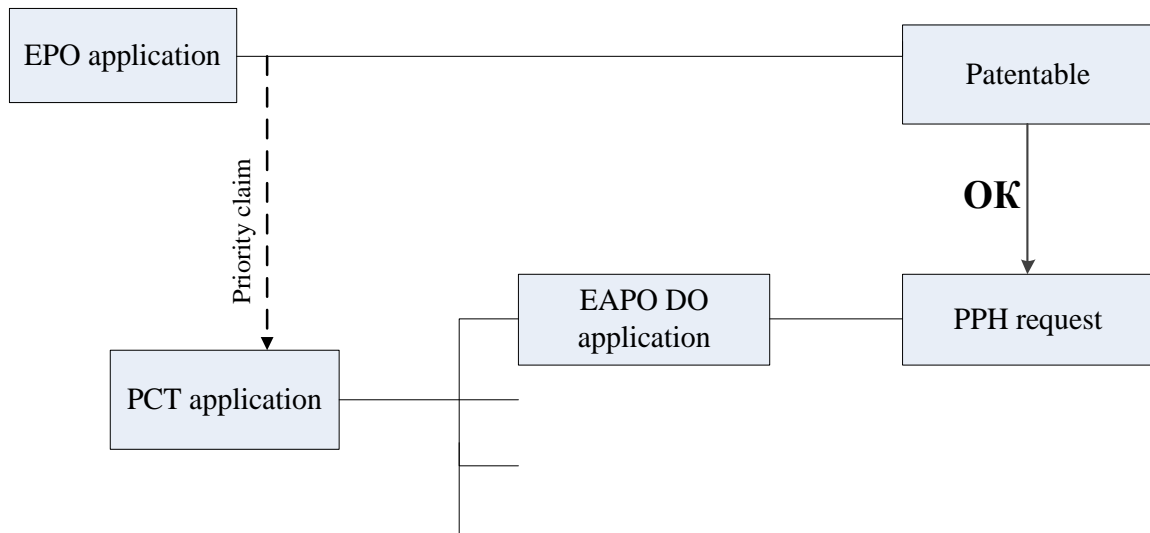

DO = Designated Office

C

Example 1 – Procedure in compliance with the Paris Convention, complex priority

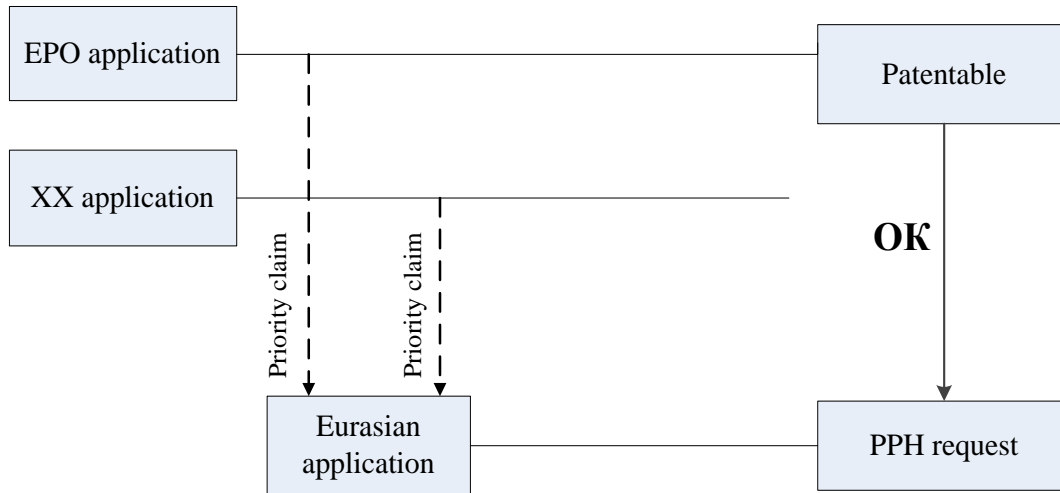

XX = any office

D

Example 1 – Procedure in compliance with the Paris Convention, divisional application

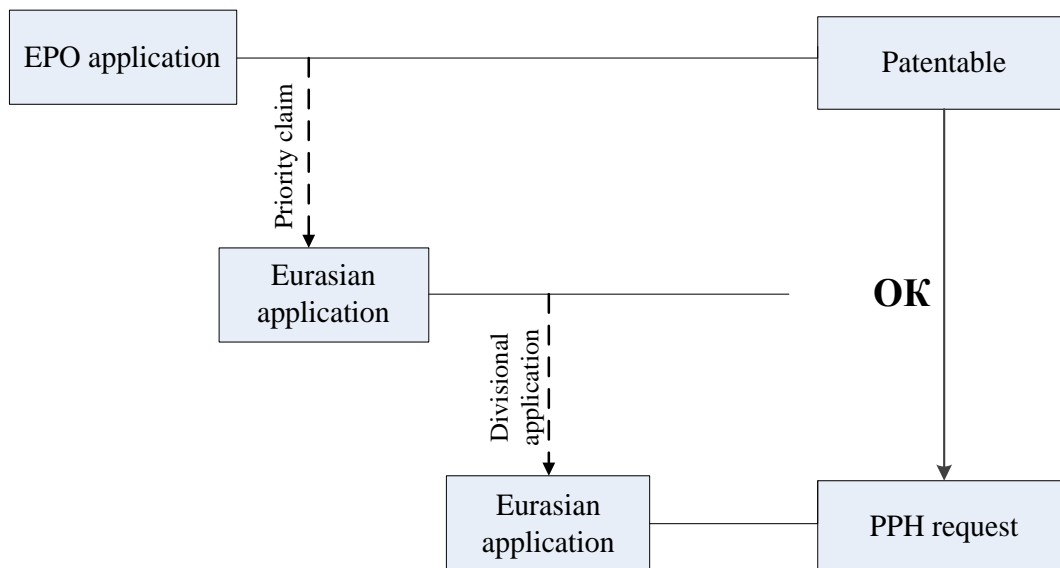

E

Example 2 – Procedure in compliance with the Paris Convention

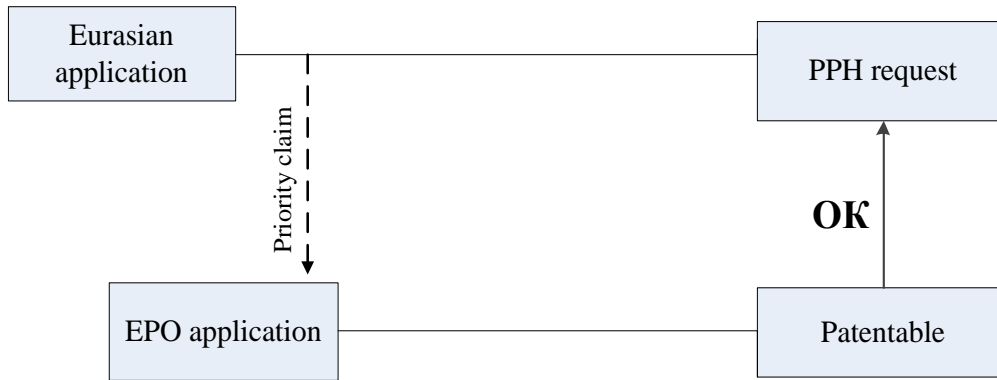

F

Example 2 – Procedure in compliance with the PCT

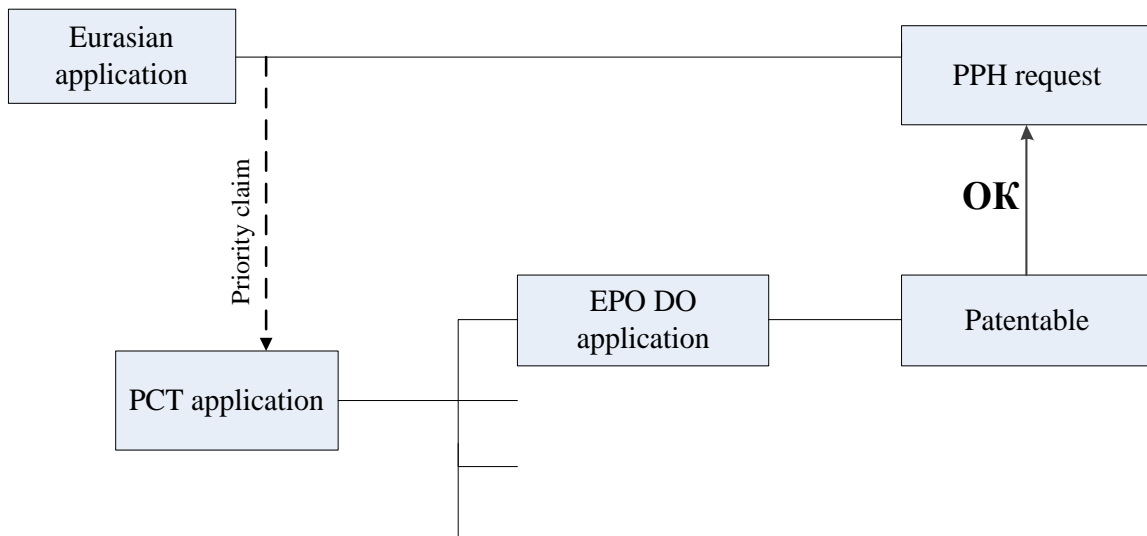

DO = Designated Office

G

Example 3 – Procedure in compliance with the Paris Convention, complex priority

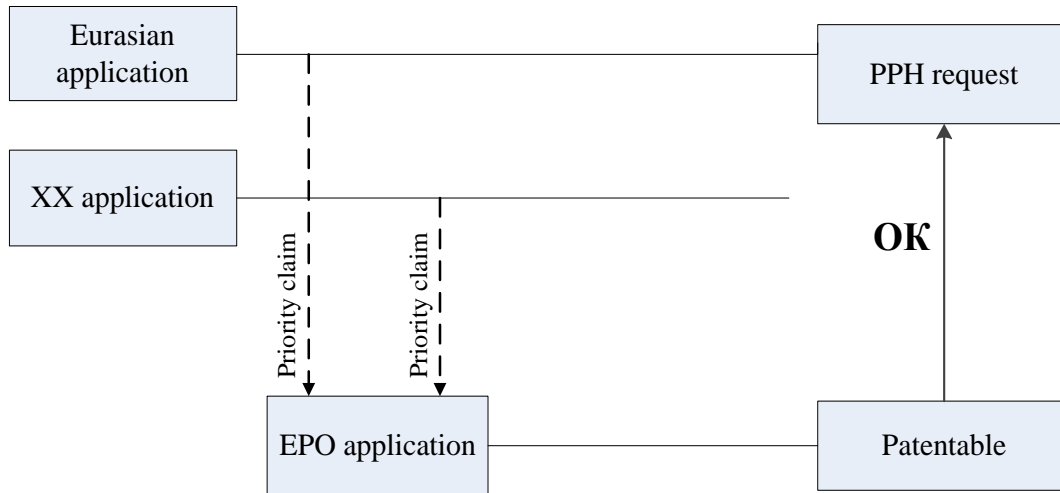

XX = any office

H

Example 3 – Procedure in compliance with the Paris Convention, domestic priority

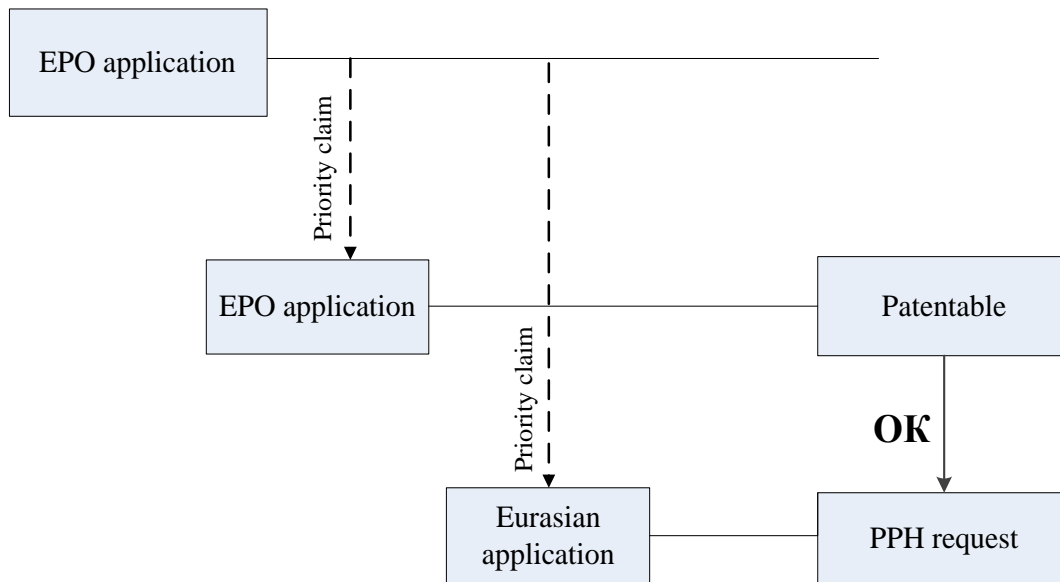

I

Example 3 – Procedure in compliance with the Paris Convention, but the prior application is from a third country

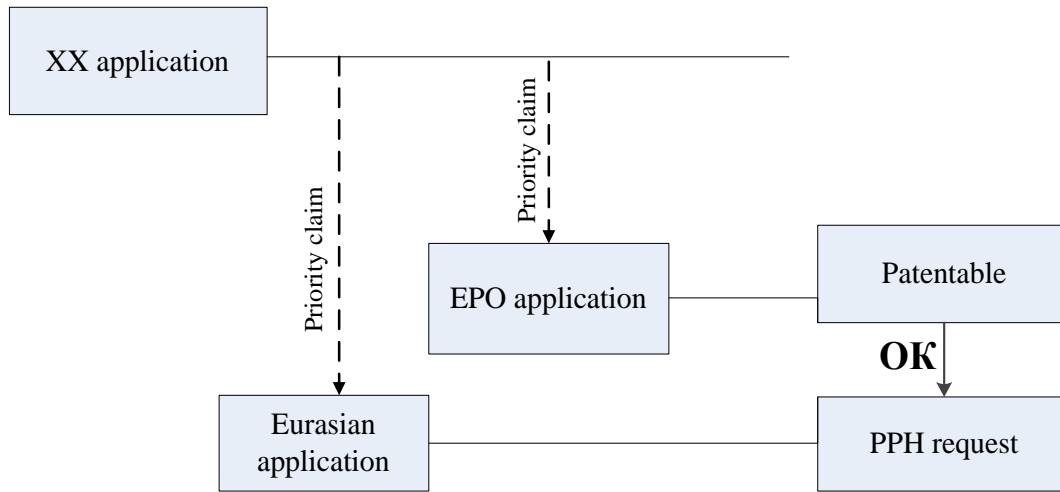

XX = any office

J

Example 3 – Procedure in compliance with the PCT, but the prior application from a third country

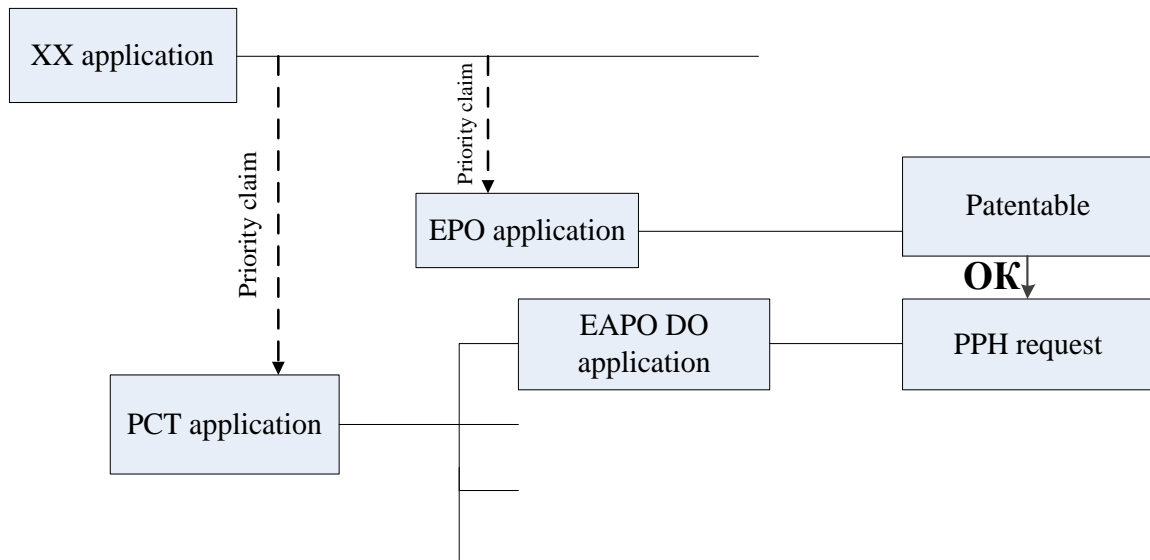

DO = Designated Office
XX = any office

K

Example 3 – Procedure in compliance with the PCT

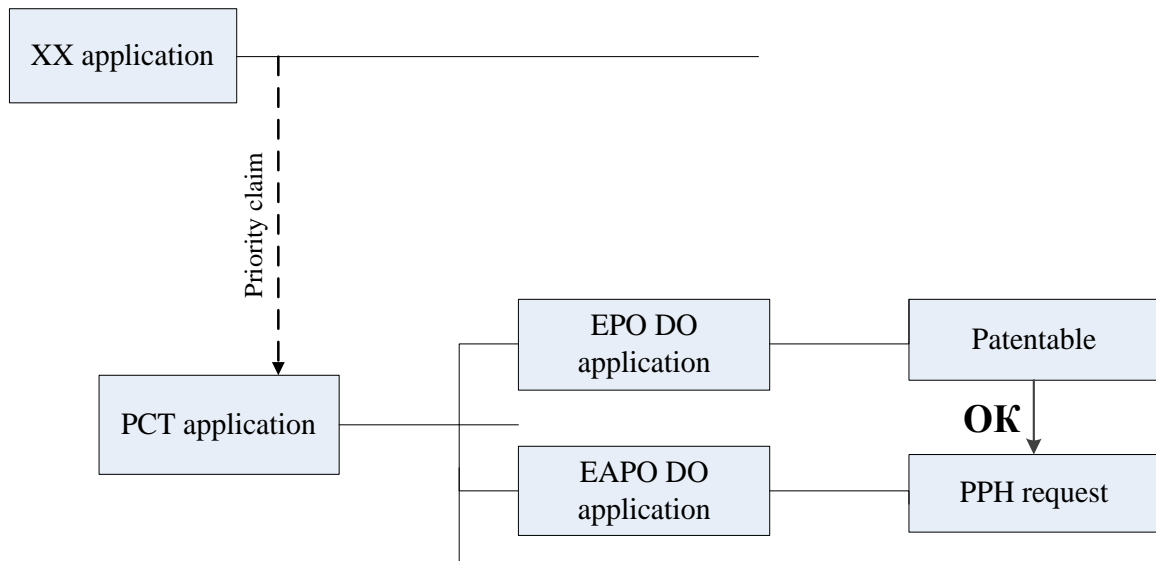

DO = Designated Office
XX = any office

L

**Example 3 – Procedure in compliance with the PCT
(without priority and with priority)**

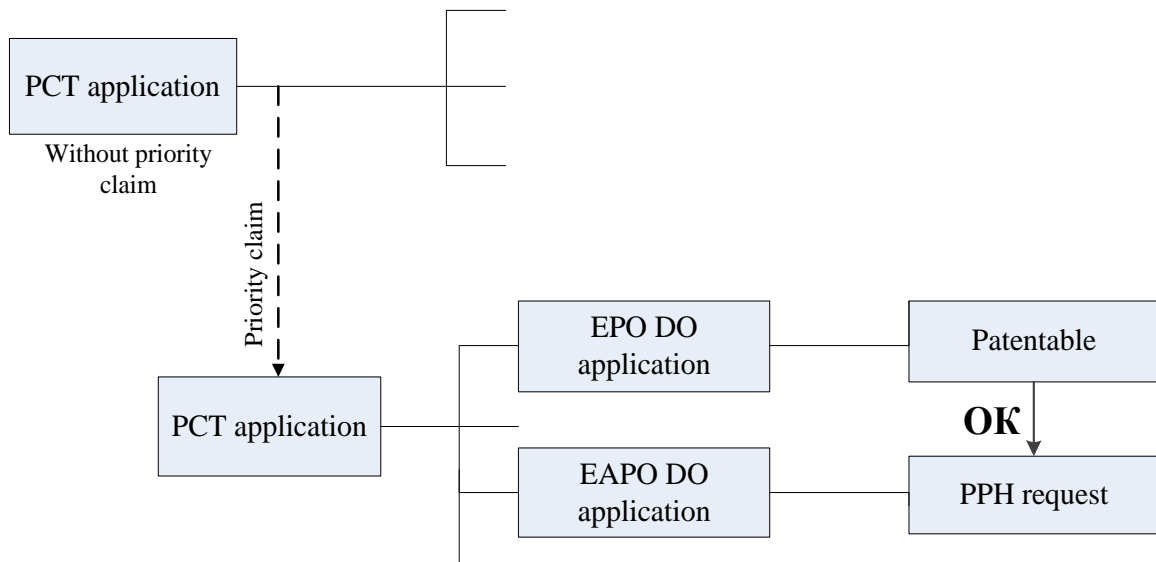

DO = Designated Office



**Example 4 – Procedure in compliance with the PCT
(without priority)**

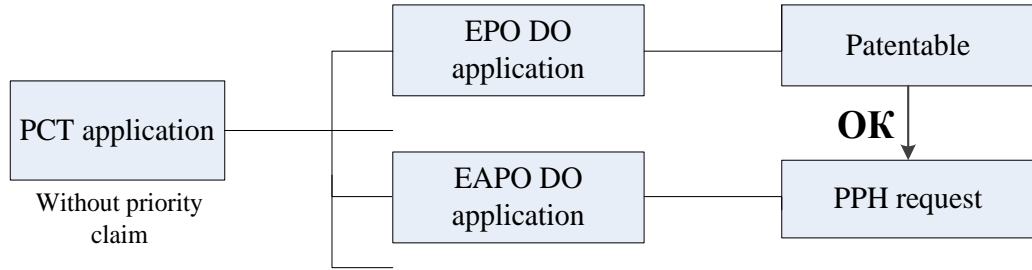

DO = Designated Office

A1

**Example: Corresponding PCT application,
transferred into regional phase in EAPO**

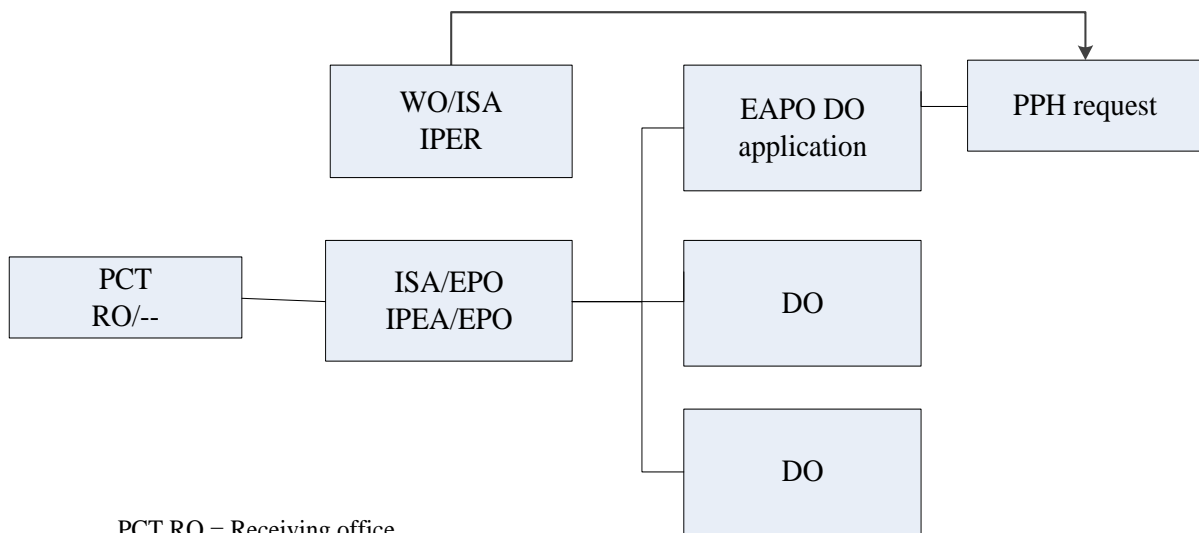

PCT RO = Receiving office
WO/ISA IPER = International preliminary report on patentability
DO = Designated office

A2

Example: Corresponding PCT application, transferred into regional phase in EAPO (Corresponding PCT application with priority request on the bases of the national application)

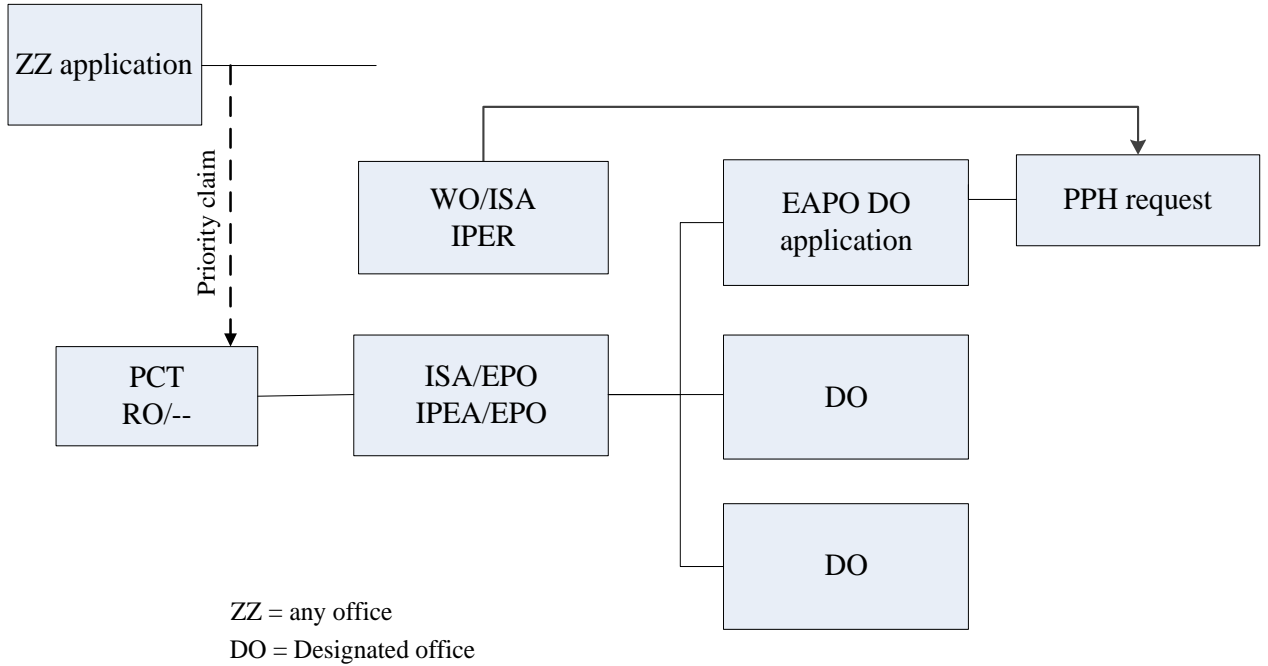

A3

Example: Corresponding PCT application, transferred into regional phase in EAPO (Corresponding PCT application with priority request on the bases of PCT application)

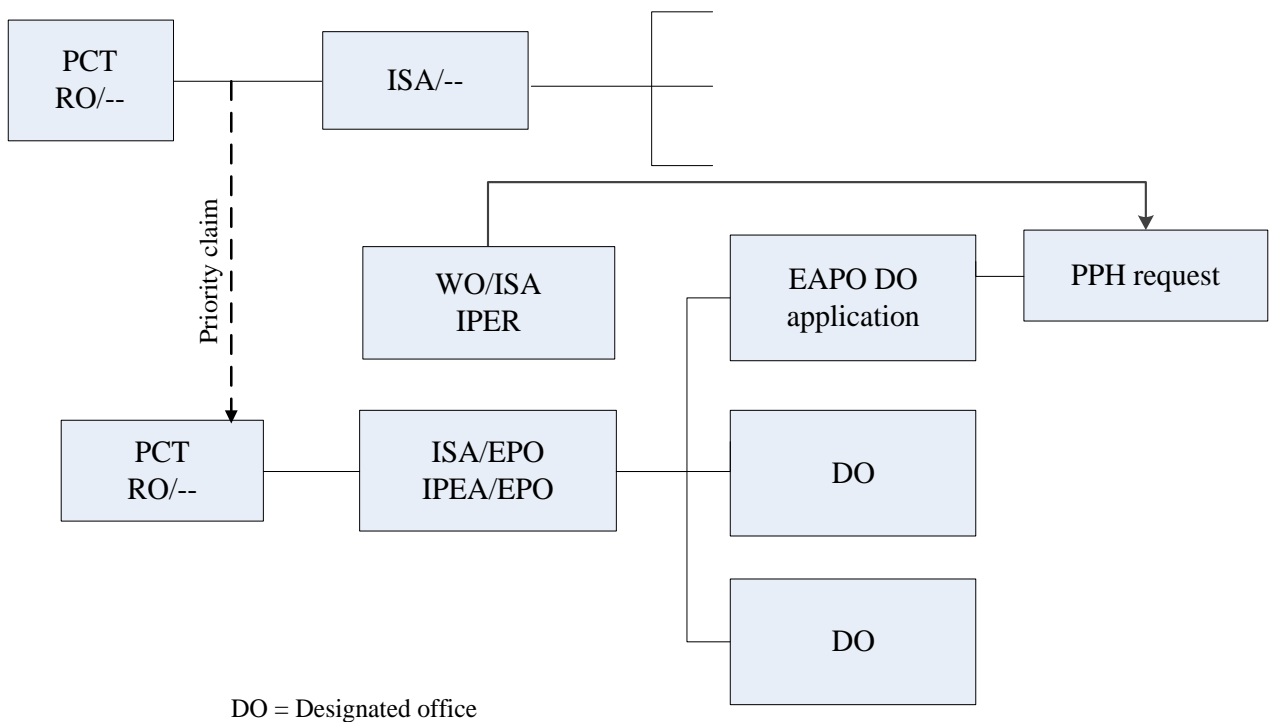

B

Example: Eurasian application on the basis of which priority for the corresponding PCT application is requested

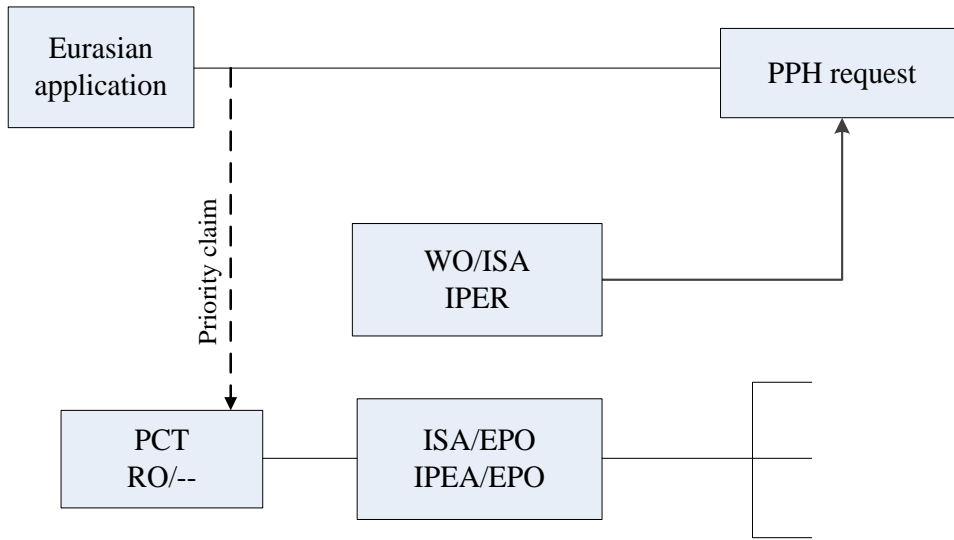

C

Example: PCT application transferred into EAPO regional phase for which priority is requested based on the corresponding PPH application

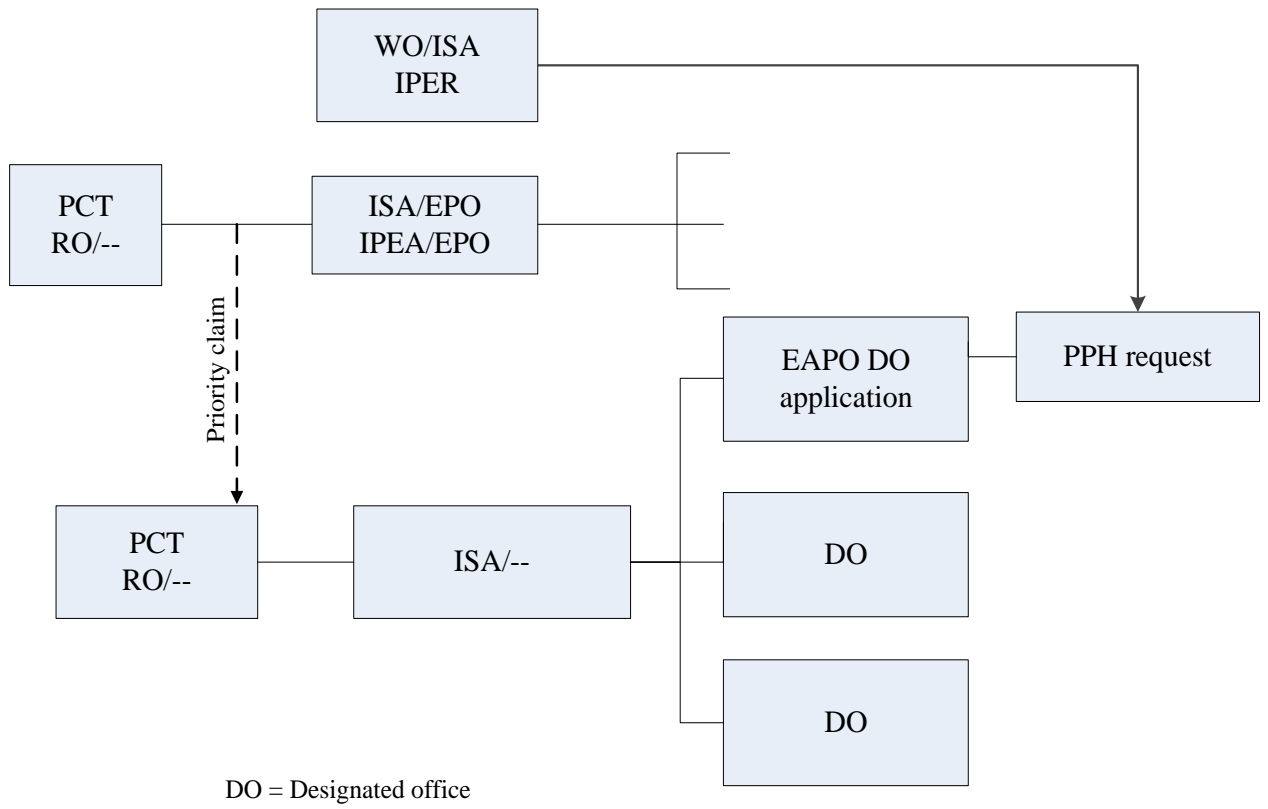

D

Example: Eurasian application for which priority is requested based on the corresponding PCT application

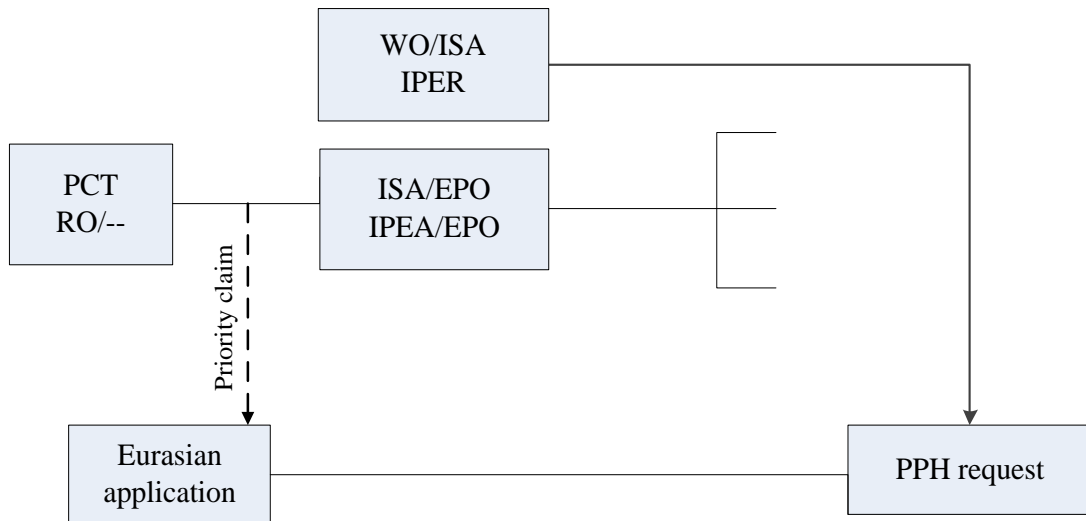

E1

Example: Divisional Eurasian application which meets the requirements of (A1-A3)

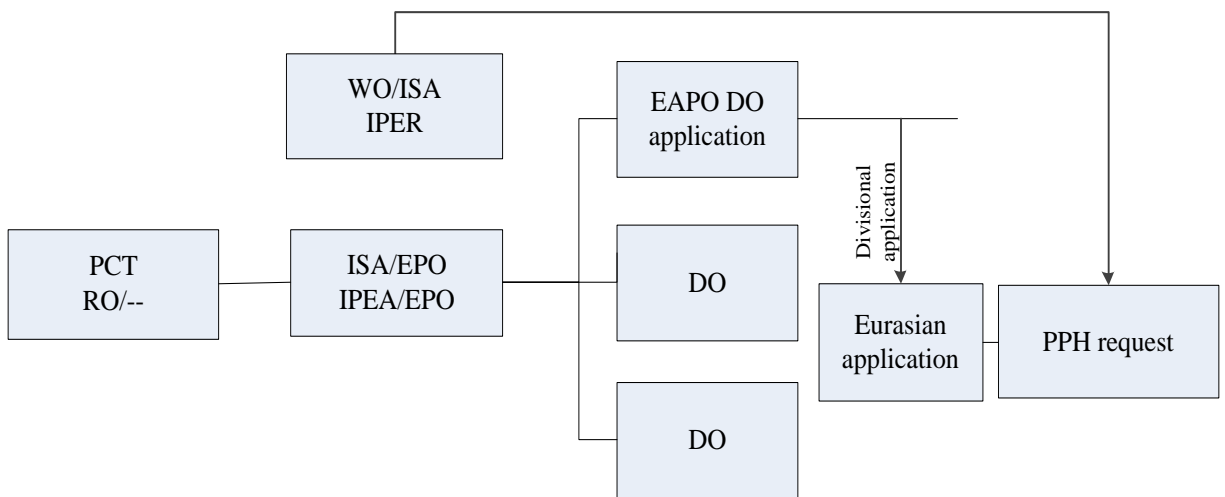

DO = Designated office

E2

Example: Eurasian application for which domestic priority is requested based on an application which meets the requirements of (B)

